

JM.. 油压虎钳

Universal Oil Vise

是铣床、钻床的随机附件，将其固定在机床工作台上，用来夹持工件进行切削加工。实现快速夹紧与快速松开，且能保证夹紧力大小。

It is a random accessory of milling machine and drilling machine, which is fixed on the worktable of the machine to clamp the workpiece for cutting. Rapid clamping and quick release are achieved, and the clamping force can be ensured.

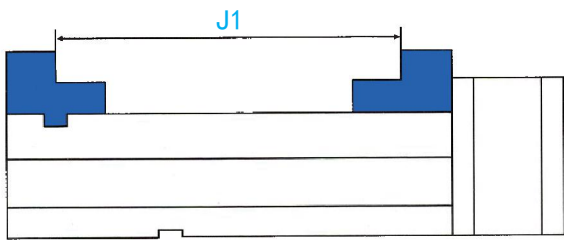
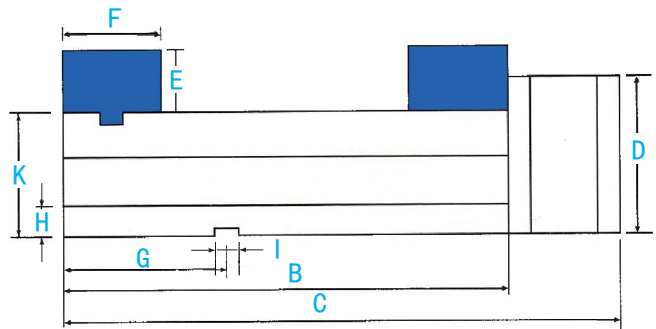
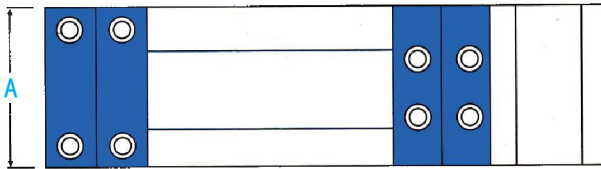
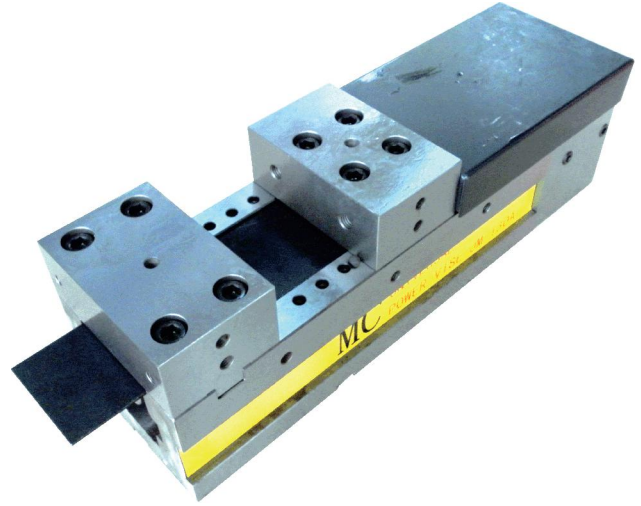

>> Dimensions (mm)

型号 Type	Dimensions 尺寸	订购编码 Order Number	A	B	C	D	E	F	G	H	I	J	J1	K	订购编码 Max. Pressure kgf/cm ² (Mpa)	重量 Weight (kg)	单价 Price (RMB)
JM-100A		709900	102	273	365	100	45	68	112	14	14	137	205	85	35 (3.4)	-	10600
JM-130A		709902	130	365	457	128	50	80	135	18	18	205	285	100	40 (3.9)	-	12600
JM-160A		709904	160	455	550	158	55	86	145	18	18	283	369	110	40 (3.9)	-	15000

5568

电控永磁吸盘

ELECTRICITY CONTROLS PERMANENT MAGNETIC CHUCK

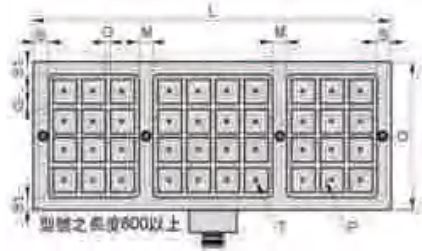
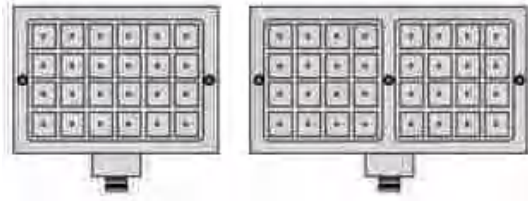

Order No.	Model	尺寸							磁极数	电压	电流 A/MP	磁极净重	控制器净重	Price
		W	L	S	S1	M	T	高度						
5568-2540	EPM2540W	240	430					18	18	42			30000	
5568-2560	EPM2560W	240	590			30		24	24	63			36225	
5568-2580	EPM2580W	240	750			30		30	30	84			45900	
5568-2590	EPM2590W	240	870			30		36	36	94			50025	
5568-25100	EPM25100W	240	990			30		42	40	105			56100	
5568-3030	EPM3030W	300	310					16	16	38			27750	
5568-3040	EPM3040W	300	430					24	24	51	10		35250	
5568-3060	EPM3060W	300	590			30		32	28	76			44925	
5568-3080	EPM3080W	300	750			30		40	32	102			58200	
5568-3090	EPM3090W	300	870			30		48	40	115			62250	
5568-30100	EPM30100W	300	990			30		56	40	127			70950	
5568-4040	EPM4040W	420	430	30	25			36	18	68			48000	
5568-4050	EPM4050W	420	480					42	26	84			54075	
5568-4060	EPM4060W	420	590			30		48	24	102			61725	
5568-4080	EPM4080W	420	750			30		60	30	135			80250	
5568-4090	EPM4090W	420	870			30		72	36	152			90000	
5568-40100	EPM40100W	420	990			30		84	40	168			102750	
5568-5060	EPM5060W	480	590			30		56	28	126			69375	
5568-5080	EPM5080W	480	750			30		70	35	168			94500	
5568-5090	EPM5090W	480	870			30		84	40	189			102000	
5568-50100	EPM50100W	480	990			30		98	50	210	15		116250	
5568-6060	EPM6060W	600	590			30		72	36	152			89250	
5568-6080	EPM6080W	600	750			30		90	40	203			116250	
5568-6090	EPM6090W	600	870			30		108	45	227			127500	
5568-60100	EPM60100W	600	990			30		126	50	252			150000	
5568-8080	EPM8080W	750	780			30		120	45	268			145500	

5750

可倾斜虎钳 UNIVERSAL 3-WAY ANGLE VISE

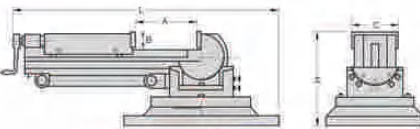
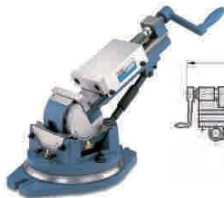

Order No.	Model	A	B	C	H	L	Vertical Height	N.W. (Kg)	Price
5750-03	VW3	90	30	80	150	396	386	17	4175
5750-04	VW4	105	38	106	172	460	470	33	4885
5750-05	VW5	140	40	132	205	625	590	45	6815

5760

角固式虎钳 PRECISION ANGLE LOCK MACHINE VISE

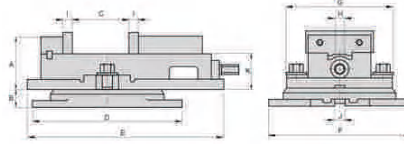

Order No.	Model	N.W. (Kg)
5760-40	LV40	20
5760-50	LV50	29
5760-60	LV60	41
5760-80	LV80	800
5760-120	LV120	125

Model	A	B	C	D	E	F	G	H	I	J	K	Price											
LV40	87	327/64	30	115/18	107	4	242	9 1/2	318	233/64	230	9 1/16	172	63/4	14	9/16	15	19/32	16	5/8	58	2 9/32	2890
LV50	98	355/64	32	114	110	4 1/4	280	11	355	34	256	10 1/16	210	81/4	15	19/32	15	19/32	16	5/8	66	2 19/32	3010
LV60	110	4 1/4	40	112	138	5 1/2	336	13 1/4	405	5 15/16	300	11 3/4	238	93/8	19	3/4	18	3/4	18	3/4	72	2 54/64	3795
LV80	138	5 27/64	55	2 3/16	198	7 3/4	422	16 5/8	555	21 3/4	380	15	305	12	19	3/4	24	15/16	18	3/4	84	3 5/16	5620
LV120	219	5 5/8	-	-	320	12 5/8	-	-	738	28 1/16	-	-	408	161/16	19	3/4	24	15/16	-	-	102	4	18545

5765

角固式光面直角虎钳

LOCK-TIGHT PRECISION MACHINE VISE

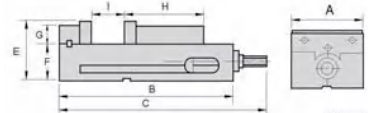

Order No.	Model	A	B	C	E	F	G	H	I	N.W. (Kg)	Price
5765-40	LG40	100	220	320	133	65	38	115	110	13kg	3105
5765-50	LG50	125	240	360	146	70	38	132	130	22kg	3280
5765-60	LG60	150	290	430	161	72	48	170	150	37kg	3450
5765-80	LG80	200	370	600	193	85	58	190	210	65kg	6730

5766

角固式虎钳 PRECISION ANGLE LOCK MACHINE VISE

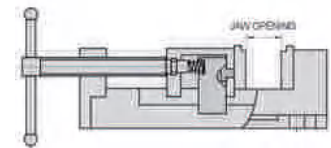

Order No.	Model	JAW PLATE HEIGHT	JAW PLATE HEIGHT	JAW OPENING	N.W. (Kg)	Price
5766-100	HDV-100	43	100	90	6.6kg	1615
5766-130	HDV-130	43	130	90	8.2kg	2280

5770

平面油压虎钳 HYDRAULIC MACHINE VISE

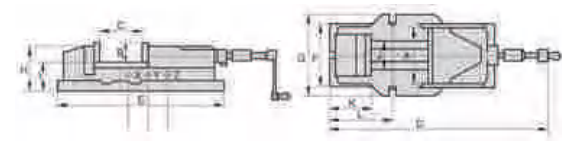

Order No.	Model	A	B	C	D	E	F	G	H	I	J	K	L	Clamping Force	N.W. (Kg) Body	N.W. (Kg) Swivel Base	Price
5770-100	HVA100	100	36	170	525	430	130	160	94	60	78	100	155	2500	16	6	4600
5770-125	HVA125	125	46	220	670	540	165	185	118	72	97	117	185	3500	33	7	5960
5770-150	HVA150	150	51	300	800	620	200	240	133	82	116	125	247	4500	54	16	5160
5770-200	HVA200	200	62	300	900	700	225	280	160	100	160	150	265	8500	90	20	9810

中空卡盘

中实卡盘

立式卡盘

气动卡盘

生爪硬爪

车床刀套

刀座

精密夹头

手动卡盘

顶针

铣床虎钳配件

磨床磁盘

工具万力

线割配件

机床工具

车床卡盘

铣床虎钳

磨床磁盘

线割配件

机械工具

中空卡盘

中实卡盘

立式卡盘

气动卡盘

生爪硬爪

车床刀套

刀座

精密夹头

手动卡盘

顶针

铣床虎钳配件

磨床磁盘

工具万力

线割配件

机床工具

车床卡盘

铣床虎钳

磨床磁盘

线割配件

机械工具

5775

双向油压虎钳 TILTING HYDRAULIC MACHINE VISE

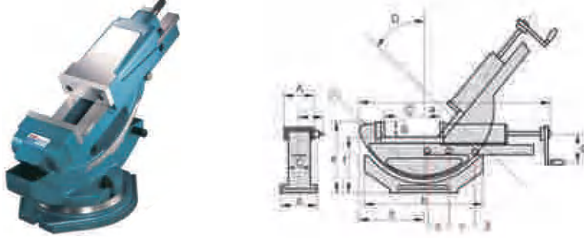

Order No.	Model	Unit:mm											N.W.(Kg) Body	N.W.(Kg) Swivel Base	Price	
		A	B	C	D	a	b	c	d	e	f	g				h
5775-100	HVW100	100	36	170	50	50.5	32.5	65	160	177	141	80	170	23	4	8565
5775-150	HVW150	150	51	300	50	77.5	41.0	95	240	237	186	100	200	60	10	10420

5780

倍力内藏式增压虎钳 MECHANICAL POWER MACHINE VISE

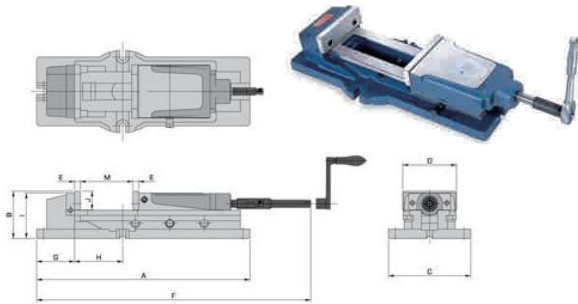

Order No.	Model	Unit:mm											N.W.(Kg)	Price
		A	B	C	D	E	F	G	H	I	J	M		
5780-50	HMP50	538	118	185	130	15	670	105	82	117	46	220	38kg	8540
5780-60	HMP60	620	133	240	154	17	800	110	140	132	54	300	58kg	9015
5780-80	HMP80	700	162	280	206	21	900	135	118	160	62	300	105kg	16130

5782

高级倍力外藏式增压虎钳 SUPER OPEN QUICK ACTION VISE

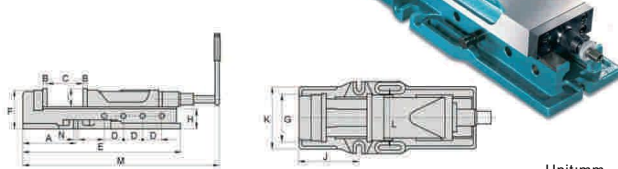

Order No.	Model	Unit:mm													N.W.(Kg)	Price	
		A	B	C	D	E	F	G	H	I	J	K	L	M			N
5782	HMP60A	200	18	300	77	610	139	158	82	63	200	240	190	915	18	58kg	10265

5785

向量式精密光面直角虎钳 PRECISION SUPER VISE

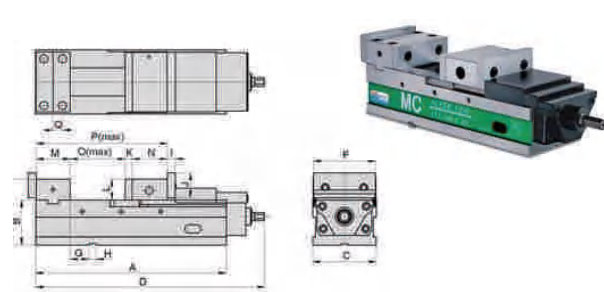

HVL100, 125, 160 is horizontal& vertical 2 way vise.

Order No.	Model	Unit:mm											N.W.(Kg)	Price						
		A	B	C	D	E	F	G	H	I	J	K			L	M	N	O	P	Q
5785-40	HVL100	324	85	104	437	130	102	32	18	17	55	15	45	73	86.5	140	314.5	20	27kg	7780
5785-50	HVL125	390	100	127	480	153	124.7	57	18	20	63	15	53	78	87.5	201	381.5	22.5	43kg	9965
5785-60	HVL160	485	115	161	625	168	159.2	49	18	20	63	18	53	86	80	295	479	25	71kg	12810

5786

倍力增压式精密光面直角虎钳 MECHANICAL POWER MACHINE VISE

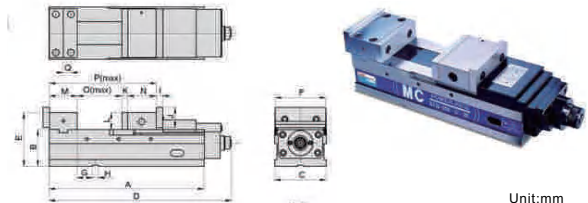

Order No.	Model	Unit:mm																N.W.(Kg)	Price	
		A	B	C	D	E	F	G	H	I	J	K	L	M	N	O	P			Q
5786-40	HVQ100	324	85	104	428	130	102	32	18	17	55	15	45	73	86.5	140	314.5	20	30kg	11385
5786-50	HVQ125	390	100	127	495	153	124.7	57	18	20	63	15	53	78	87.5	201	381.5	22.5	46kg	12810
5786-60	HVQ160	485	115	161	605	168	159.2	49	18	20	63	18	53	86	80	295	479	25	71kg	15940
5786-60L	HVQ160L	515	115	161	635	168	159.2	67	18	20	63	18	53	86	80	330	514	25	76kg	20400
5786-80	HVQ200	535	120	202	655	178	199.5	66	18	20	73	18	58	101	95	320	534	31	100kg	17080
5786-80L	HVQ200L	585	120	202	713	178	200	84	18	20	73	18	58	101	95	367.5	581.5	31	108kg	20880

5788

多功能CNC角固式精密光面直角虎钳 MULTI-POWER CNC PRECISION FIXED ANGLE VISE

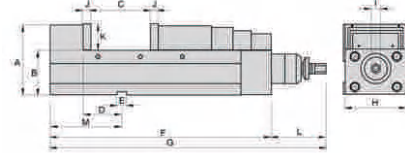

SPECIFICATIONS (Material: FCD 60, Ductile Iron, Hardness HRC50°)

Order No.	Model	Unit:mm													N.W.(Kg)	Price			
		A	B	C	C1	C2	C3	D	E	F	G	H	I	J			K	L	M
5788-130	HPAC130	147	66.01	0-190	70-280	115-305	185-375	80±0.02	18	475	583	131	19	15	55	120	150	47	13715
5788-160	HPAC160	160	116±0.01	0-250	85-325	140-375	220-460	80±0.02	18	560	670	161	19	15	58	120	165	65	16390
5788-200	HPAC200	170	116±0.01	0-290	90-380	155-440	240-530	100±0.02	18	635	743	201	19	18	63	120	197	95	21565

5792

双向向量式虎钳 Two-dimensional vector vise

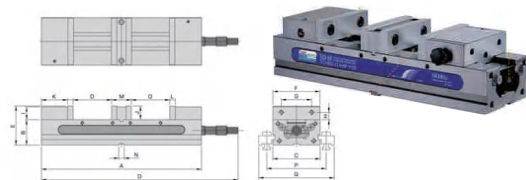

Order No.	Model	Unit:mm																N.W.(Kg)	Price	
		A	B	C	D	E	F	G	H	I	J	K	L	M	N	O	P			Q
5792-40	TLD40	405	63.5	104	459	101.5	102	63.5	17.5	33	38	69	15	55	18	90	143	195	20kg	11385
5792-60	TLD60	520	62.55	154	536	127.05	152	98.4	23.8	41.5	44.5	86.5	15	66	18	125	193	245	52kg	13285

5796

MC增压器型超高压快速虎钳 MC PRECISION SUPER HI-PRESSURE RAPID VISCE

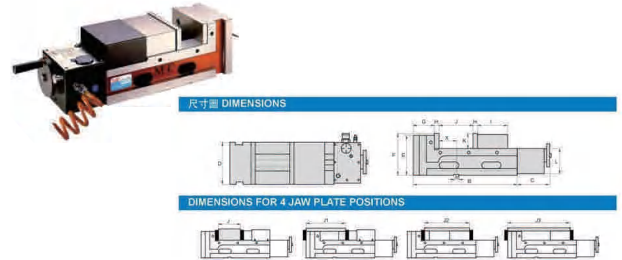

Order No.	Model	Unit:mm																夹持力 Clamping (Kg)	N.W.(Kg)	Price	
		A	B	C	D	E	F	G	H	I	J	J1	J2	J3	K	L	M				X
5796-01	TPV5150	520	380	140	130	157	160	86	15	110	0-150	35-200	110-275	200-380	55	105	18	45	6000	45	15830
5796-02	TPV6160	540	400	140	160	160	163	86	15	120	0-160	35-260	120-295	210-400	55	105	18	45	6000	47	17680
5796-03	TPV6250	630	490	140	160	160	163	86	15	120	0-230	35-300	120-350	210-480	55	105	18	45	6000	53	18720
5796-04	TPV7200	600	460	140	180	170	173	90	18	130	0-200	190-300	130-350	220-480	63	110	18	72	9000	65	19750
5796-05	TPV8200	610	470	140	200	170	173	90	18	140	0-200	190-310	140-360	230-470	63	110	18	72	9000	70	21735
5796-06	TPV8300	710	570	140	200	170	173	90	18	140	0-300	190-410	140-460	230-570	63	110	18	72	9000	79	22900

铣床虎钳/分度盘

Milling machine vice / Index plate

5810-5812

万能分度头

SEMI-UNIVERSAL CENTER (DIVIDING HEAD)

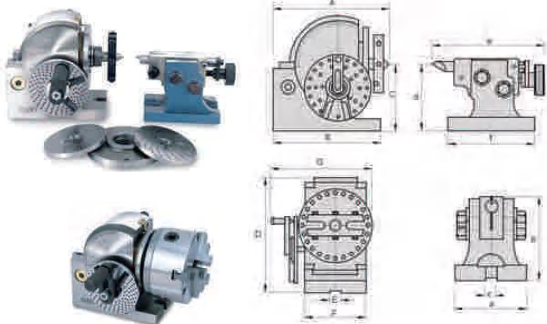

SEMI-UNIVERSAL INDEX CENTER B & S TYPE NO.0, NO.1(HEAD-STOCK) Unit:mm

Order No.	Model	A	B	C	D	E	F	G	N.W. (Kg)	Price							
5810	BS0	189	77/16	160	6 19/64	100	3 15/16	173	6 13/16	16	5/8	91	3 37/64	140	5 33/64	22	7420
5812	BS1	293	11 11/32	210	8 17/64	128	5 3/64	220	5 3/64	16	5/8	114	4 31/64	156	6 9/64	36	9750

SEMI-UNIVERSAL INDEX CENTER B & S TYPE NO.0, NO.1(TAIL-STOCK) Unit:mm

Model	a	b	c	d	e	f	Taper of Center	Diameter of Spindle hole						
BS0	90	3 35/64	105	4 9/64	16	5/8	100	3 15/16	166	6 34/64	127	5	B&S No.7	18
BS1	108	4 1/4	134	5 9/32	16	5/8	128	5 29/32	184	7 1/4	150	5 29/32	B&S No.9	20

STANDARD ACCESSORIES

Dividing plate A, B, C.

Numbers of holes of dividing plate (worm gear reduction ratio 1:40)

Numbers of holes	Unit:mm						
	Plate A	15	16	17	18	19	20
	Plate B	21	23	27	29	31	33
	Plate C	37	39	41	43	47	49

5820

横立两用分度盘

HORIZONTAL AND VERTICAL ROTARY TABLE

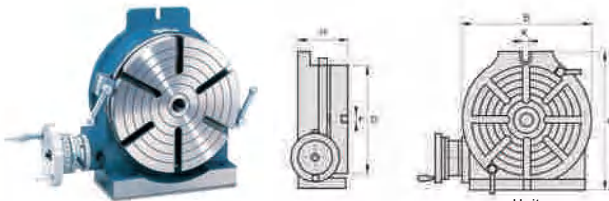

Order No.	Model	Table		Base Dimension		Bolt Slots K	Center sleeve	Worm Gear Ratio	N.W. (Kg)	Price
		D	H	A	B					
5820-15	HV150	150	92	220	160	18	MT-2	90 1	12.5	3880
5820-20	HV200	200	120	310	225	18	MT-3		31.0	5450
5820-25	HV250	250	120	320	280	18	MT-3		48.5	6790
5820-30	HV300	300	140	410	325	18	MT-4		77.0	8660
5820-35	HV350	350	140	460	380	18	MT-4		98	11095
5820-40	HV400	400	140	510	435	18	MT-5		130	16045

5821

尾座

TAIL STOCK

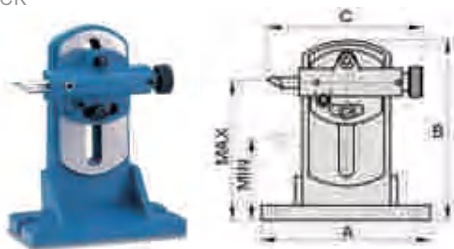

Order No.	Model	Suitable for	A	B	C	Center Height		N.W. (Kg)	Price
						Max.	Min.		
5821-01	TS1	HV-200/HV-250	230	247	210	190	110	13	1440
5821-02	TS2	HV-300	230	280	210	220	140	15	1520
5821-03	TS3	HV-350/HV-400	230	330	210	264	184	17	1900

5865

万能可调倾斜式角度盘

ANGLE PLATE+CONNECTING PLATE+SWIVELBASE

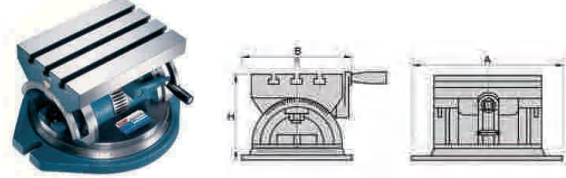

Order No.	Model	A	B	H	Unit:mm		Price
					T-SLOT e	N.W. (Kg)	
5865-01	HAP180S	265	220	135	12	12	5350
5865-02	HAP250S	350	305	185	12	40	8025
5865-03	HAP380S	490	436	240	16	100	12075

5855

万能倾斜分度盘

UNIVERSAL TILTING ROTARY TABLE

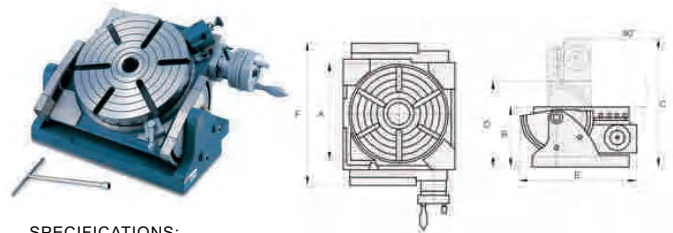

SPECIFICATIONS:

Order No.	Model	Table Diameter A	Table Height Horizontal (B)	Table Height Vertical (C)	Center Height Vertical (D)	E	F	Gear Ratio	Center Hole	Direct Indexing	N.W. (Kg)

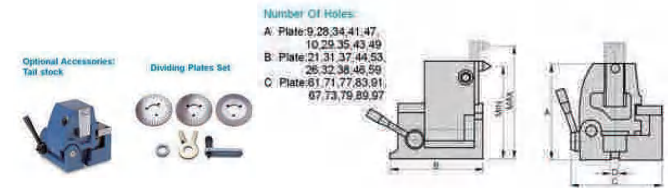

Order No.	Model	A	B	C	D	Center Height		N.W. (Kg)	Price
						Max	Min		
5855	HUT300	200	196	190	16	230	113	23	27420

中空卡盘

中实卡盘

立式卡盘

气动卡盘

生爪硬爪

车床刀套

刀座

精密夹头

手动卡盘

顶针

铣床虎钳配件

磨床磁盘

工具万力

线割配件

机床工具

车床卡盘

铣床虎钳

磨床磁盘

线割配件

机械工具